

ARTIKAL
Item

J362002

Baterija za električni prelivni bojler
Wall sink mixer, low pressure

SLIKA PROIZVODA Product picture



TEHNIČKA SKICA Technical draft

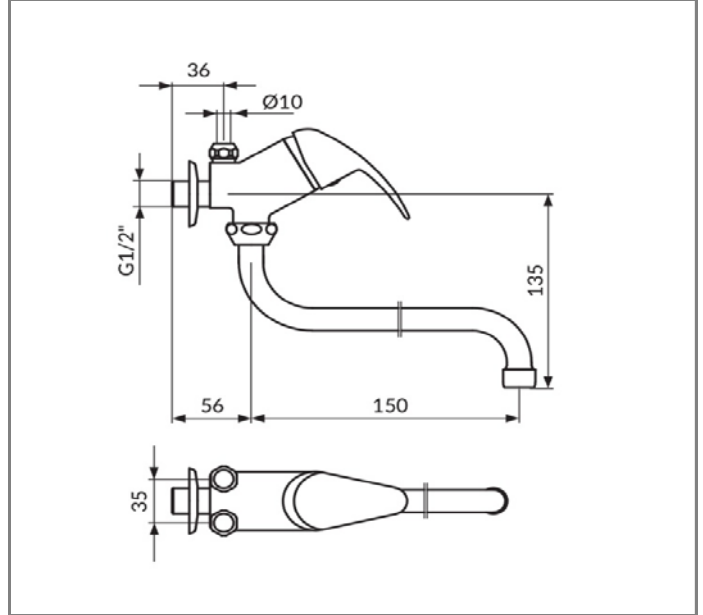

TEHNIČKI PODACI

Jednoručna baterija
Zidna montaža
Otvorena veza bojler-baterija
Smanjeni protok 3 - 5 lit/min
Usmerivač NEOPERL® NEOSTRAHL®
Keramički mešač KEROX® 40 NDO HWS
Pokretni izliv 150mm
Hromirana rozeta
Klasa bučnosti II

TECHNICAL DETAILS

Single lever mixer
Wall mounted
Open flow waterheater-mixer
Reduced flow rate 3 - 5 lit/min
NEOPERL® NEOSTRAHL® Flow Straightener
Ceramic cartridge KEROX® NDO 40 HWS
Swivel spout 150mm
Chromed rossete
Noise level II

RADNI USLOVI

Maksimalni radni pritisak: 5 bar
Preporučeni radni pritisak: 3 bar
Minimalni radni pritisak: 1 bar
Maksimalna dozvoljena temperatura: 80°C
Preporučena temperatura vode: 60°C

WORKING CONDITIONS

Max. working pressure : 5 bar
Suggested working pressure : 3 bar
Min. working pressure : 1 bar
Max. working temperature : 80°C
Suggested max. water temperature : 60°C

www.rosan.rs

Srbija, 24420 Kanjiža, Dušana Popovića 10.

tel.+381 24-876-744 fax +381 24-876-756, info@rosan.rs

KING