

ARTIKAL
Item

JA381003

BATERIJA ZA ELEKTRIČNI PRELIVNI BOJLER
Wall type mixer, low pressure

SLIKA PROIZVODA Product picture



TEHNIČKA SKICA Technical draft

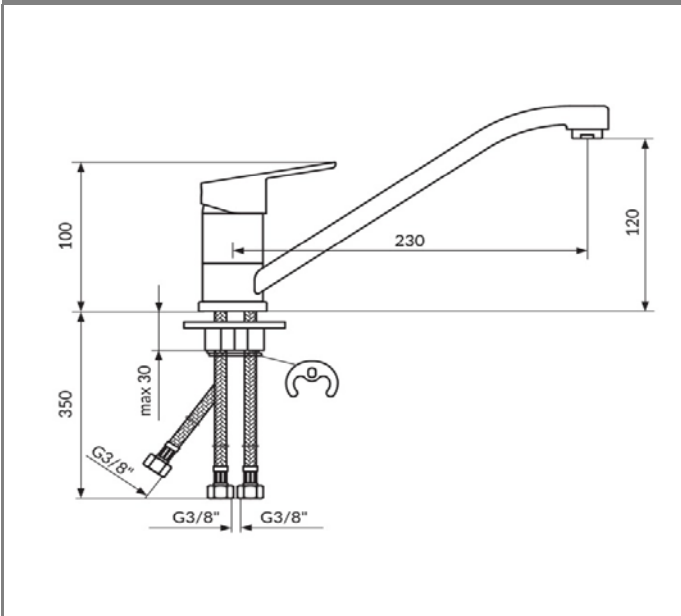

TEHNIČKI PODACI

Jednoručna baterija
Montiranje na jedan otvor
Otvorena veza bojler-baterija
Smanjeni protok 3 - 5 lit/min
Keramički mešač KEROX® 35 NDO HWS
Usmerivač NEOPERL® NEOSTRAHL®
Pokretni izliv 360°
Set za pričvršćenje sa jednim vijkom
CSTB/KIWA sertifikovana fleksibilna priključna creva
Klasa bučnosti II

TECHNICAL DETAILS

Single lever mixer
Single hole assembly
Open connection waterheater - mixer
Reduced flow 3 - 5 lit/min
Ceramic cartridge KEROX® 35 NDO HWS
Flow straightener NEOPERL® NEOSTRAHL®
Swivel spout 360°
Single screw fixing set
CSTB/KIWA Certified flexible connection hoses
Noise class II

RADNI USLOVI

Maksimalni radni pritisak: 5 bar
Preporučeni radni pritisak: 3 bar
Minimalni radni pritisak: 1 bar
Maksimalna dozvoljena temperatura: 80°C
Preporučena temperatura vode: 60°C

WORKING CONDITIONS

Max. working pressure : 5 bar
Suggested working pressure : 3 bar
Min. working pressure : 1 bar
Max. working temperature : 80°C
Suggested max. water temperature : 60°C

www.rosan.rs

Srbija, 24420 Kanjiža, Dušana Popovića 10.

tel.+381 24-876-744 fax +381 24-876-756, info@rosan.rs

SMART