

ARTIKAL
Item

JP382013

Baterija za sudoperu, električni prelivni bojler
Sink mixer, low pressure

SLIKA PROIZVODA Product picture



TEHNIČKA SKICA Technical draft

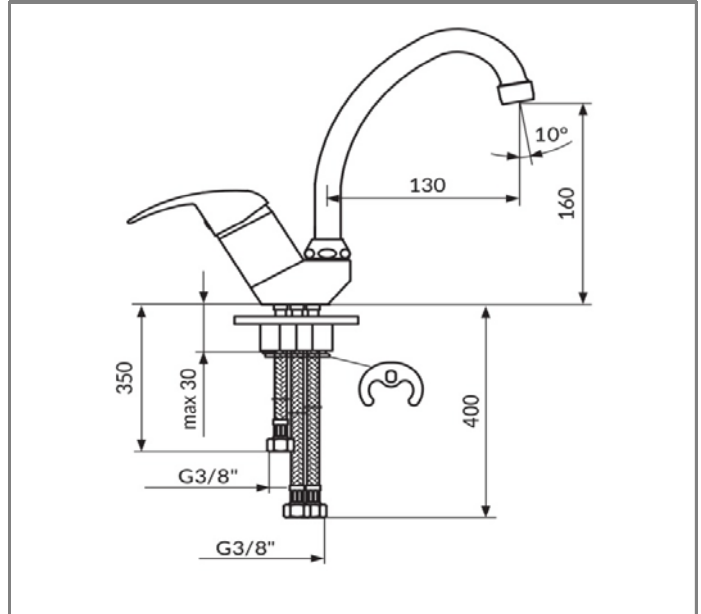

TEHNIČKI PODACI

Jednoručna baterija
Montiranje na jedan otvor
Otvorena veza bojler-baterija
Smanjeni protok 3 - 5 lit/min
Usmerivač NEOPERL® NEOSTRAHL®
Keramički mešač KEROX® 35 NDO HWS
Pokretni izliv 360°
INOX set za pričvršćenje
IMQ sertifikovana fleksibilna priključna creva
Klasa bučnosti II

RADNI USLOVI

Maksimalni radni pritisak: 5 bar
Preporučeni radni pritisak: 3 bar
Minimalni radni pritisak: 1 bar
Maksimalna dozvoljena temperatura: 80°C
Preporučena temperatura vode: 60°C

TECHNICAL DETAILS

Single lever mixer
Single hole mounted
Open flow waterheater-mixer
Reduced flow rate 3 - 5 lit/min
NEOPERL® NEOSTRAHL® flow straightener
Ceramic cartridge KEROX® NDO 35 HWS
Swivel spout 360°
Stainless Steel rapid instalation set
IMQ certified flexible connection hoses
Noise level II

WORKING CONDITIONS

Max. working pressure : 5 bar
Suggested working pressure : 3 bar
Min. working pressure : 1 bar
Max. working temperature : 80°C
Suggested max. water temperature : 60°C

www.rosan.rs

Srbija, 24420 Kanjiža, Dušana Popovića 10.

tel.+381 24-876-744 fax +381 24-876-756, info@rosan.rs

PERLA