

ARTIKAL
Item

JP523020

Jednoručni ventil za hladnu vodu
Wall tap for cold water

SLIKA PROIZVODA
Product picture



TEHNIČKA SKICA
Technical draft

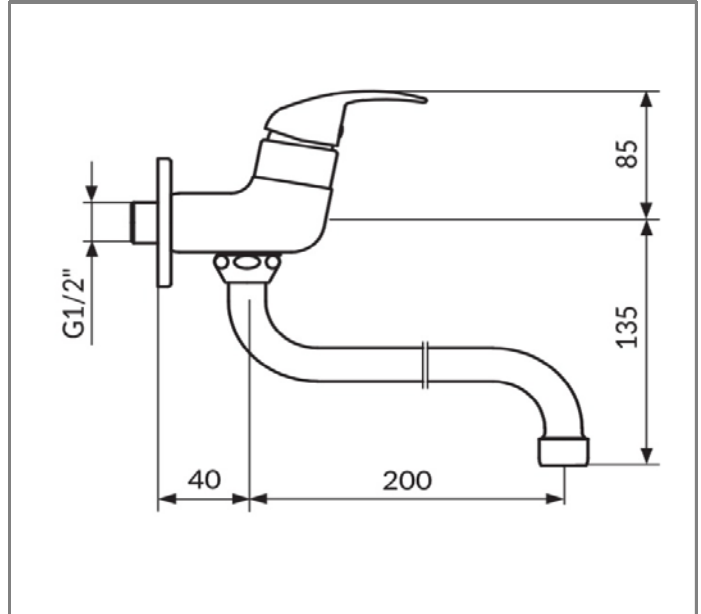

TEHNIČKI PODACI

Ventil za hladnu vodu
Montaža na zid
Klasa protoka Z - 7 lit/min
NEOPERL® PERLATOR® HONEYCOMB
Pokretni izliv 200mm
Keramički uložak PKM25A
Hromirana rozeta

TECHNICAL DETAILS

Cold water tap
Wall mounted
Flow class Z - 7 lit/min
Aerator NEOPERL® PERLATOR® HONEYCOMB
Swivel spout 200mm
Ceramic cartridge PKM25A
Chromed rosette

RADNI USLOVI

Maksimalni radni pritisak: 5 bar
Preporučeni radni pritisak: 3 bar
Minimalni radni pritisak: 1 bar
Maksimalna dozvoljena temperatura: 80°C
Preporučena temperatura vode: 60°C

WORKING CONDITIONS

Max. working pressure : 5 bar
Suggested working pressure : 3 bar
Min. working pressure : 1 bar
Max. working temperature : 80°C
Suggested max. water temperature : 60°C

www.rosan.rs

Srbija, 24420 Kanjiža, Dušana Popovića 10.

tel.+381 24-876-744 fax +381 24-876-756, info@rosan.rs

PERLA