

ARTIKAL
Item

JZ38803

BATERIJA ZA SUDOPERU za EL. PRELIVNI BOJLER
Sink mixer, low pressure

SLIKA PROIZVODA
Product picture



TEHNIČKA SKICA
Technical draft

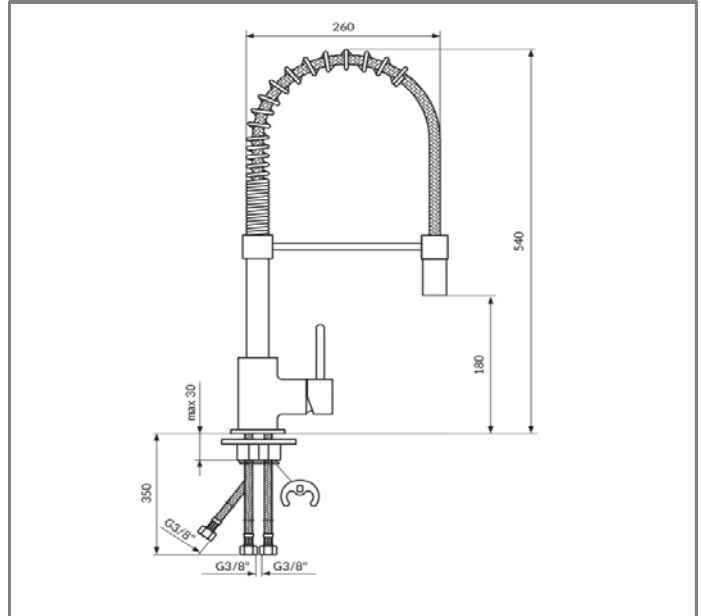

TEHNIČKI PODACI

Jednoručna baterija
Montiranje na jedan otvor
NEOPERL® NEOSTRAHL® DRIPLESS FS®
Keramički mešač KEROX® 35 A NDO HWS
360° rotacioni izliv
Set za brzo pričvršćenje on inoxa
NEOPERL® SPX® priključna creva

TECHNICAL DETAILS

Single lever mixer
Single hole mounted
Jet breaker NEOPERL® NEOSTRAHL® DRIPLESS FS®
Ceramic cartridge KEROX® 35 A NDO HWS
360° swivel spout
Stainless steel fixing set
NEOPERL® SPX® flexible connecting hoses

RADNI USLOVI

Maksimalni radni pritisak: 5 bar
Preporučeni radni pritisak: 3 bar
Minimalni radni pritisak: 1 bar
Maksimalna dozvoljena temperatura: 80°C
Preporučena temperatura vode: 60°C

WORKING CONDITIONS

Max. working pressure : 5 bar
Suggested working pressure : 3 bar
Min. working pressure : 1 bar
Max. working temperature : 80°C
Suggested max. water temperature : 60°C

www.rosan.rs

Srbija, 24420 Kanjiža, Dušana Popovića 10.

tel.+381 24-876-744 fax +381 24-876-756, info@rosan.rs

ZERRO