

ARTIKAL
Item

K01130

Baterija za sudoperu - lavabo
Wall type mixer

SLIKA PROIZVODA
Product picture



TEHNIČKA SKICA
Technical draft

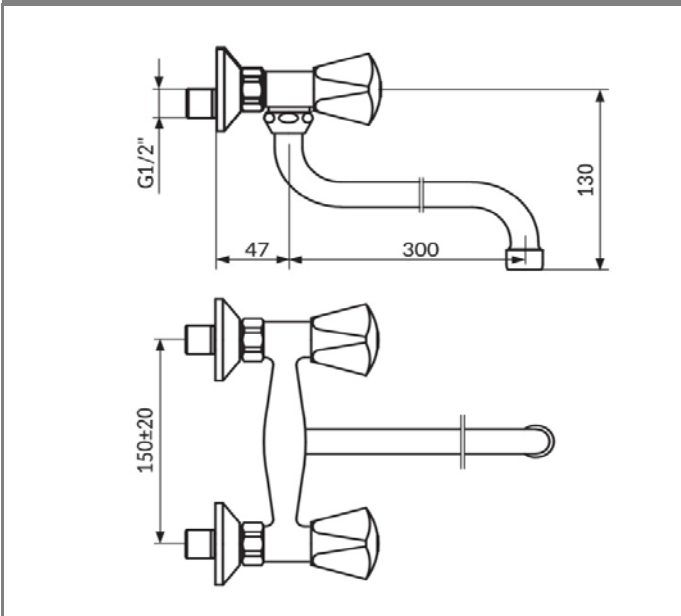

TEHNIČKI PODACI

Dvoručna baterija
Zidna montaža
Klasa protoka Z - 7 lit/min
NEOPERL® PERLATOR® HONEYCOMB
Kompresioni gornji deo sa masnom komorom 1/2"
Metalni trokraki rukohvat
Heavy Duty ekscentar kolena
Hromirane rozete
Pokretni izliv 300mm
Klasa bučnosti I

TECHNICAL DETAILS

Two handle mixer
Wall mounted
Flow class Z - 7 lit/min
Aerator NEOPERL® PERLATOR® HONEYCOMB
Compression cartridge with grease chamber 1/2"
Metal triangle handle
Heavy Duty eccentric connectors
Chromed rosettes
Swivel spout 300mm
Noise level I

RADNI USLOVI

Maksimalni radni pritisak: 5 bar
Preporučeni radni pritisak: 3 bar
Minimalni radni pritisak: 1 bar
Maksimalna dozvoljena temperatura: 80°C
Preporučena temperatura vode: 60°C

WORKING CONDITIONS

Max. working pressure : 5 bar
Suggested working pressure : 3 bar
Min. working pressure : 1 bar
Max. working temperature : 80°C
Suggested max. water temperature : 60°C

www.rosan.rs

Srbija, 24420 Kanjiža, Dušana Popovića 10.

tel.+381 24-876-744 fax +381 24-876-756, info@rosan.rs

KLASIK