

ARTIKAL
Item

KF23013

Baterija za sudoperu - lavabo
Basin - sink mixer

SLIKA PROIZVODA Product picture



TEHNIČKA SKICA Technical draft

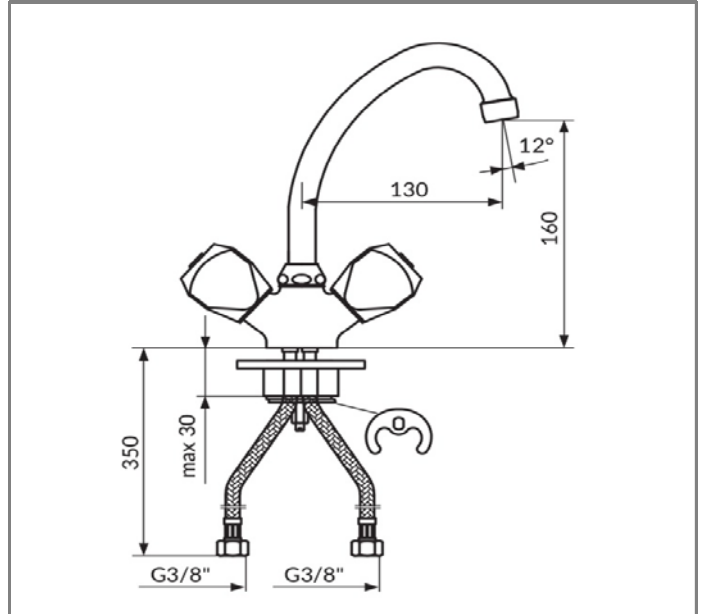

TEHNIČKI PODACI

Dvoručna baterija
Montiranje na jedan otvor
Klasa protoka S
NEOPERL® PERLATOR® HONEYCOMB
Kompresioni gornji deo sa masnom komorom 1/2"
Rukohvat dim boje
Pokretni izliv 130mm
INOX set za pričvršćenje
IMQ sertifikovana fleksibilna priključna creva
Klasa bučnosti I

TECHNICAL DETAILS

Two handle mixer
Single hole mounted
Flow class S
Aerator NEOPERL® PERLATOR® HONEYCOMB
Compression cartridge with grease chamber 1/2"
Fumme handle
Swivel spout 130mm
Stainless Steel rapid instalation set
IMQ certified flexible connection hoses
Noise level I

RADNI USLOVI

Maksimalni radni pritisak: 5 bar
Preporučeni radni pritisak: 3 bar
Minimalni radni pritisak: 1 bar
Maksimalna dozvoljena temperatura: 80°C
Preporučena temperatura vode: 60°C

WORKING CONDITIONS

Max. working pressure : 5 bar
Suggested working pressure : 3 bar
Min. working pressure : 1 bar
Max. working temperature : 80°C
Suggested max. water temperature : 60°C

www.rosan.rs

Srbija, 24420 Kanjiža, Dušana Popovića 10.

tel.+381 24-876-744 fax +381 24-876-756, info@rosan.rs

KLASIK FUMME