

- DE** Montageanleitung
- FR** Instructions de montage
- EN** assembly instructions

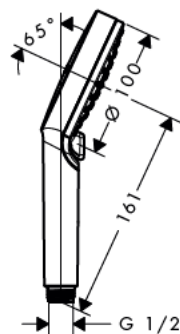

Vernis Blend Vario
26270XXX / 26085000

- DE** Reinigungsempfehlung / Garantie / Kontakt
- FR** Recommandation pour le nettoyage / Garanties / Contact
- EN** Cleaning recommendation / Warranty / Contact

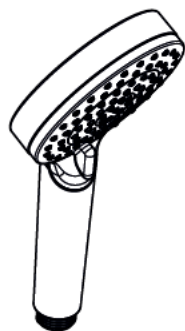

[www.hansgrohe.com/
cleaning-recommendation](http://www.hansgrohe.com/cleaning-recommendation)



[www.hansgrohe.com/
cleaning-recommendation](http://www.hansgrohe.com/cleaning-recommendation)



[www.hansgrohe.com/
cleaning-recommendation](http://www.hansgrohe.com/cleaning-recommendation)



[www.hansgrohe.com/
cleaning-recommendation](http://www.hansgrohe.com/cleaning-recommendation)

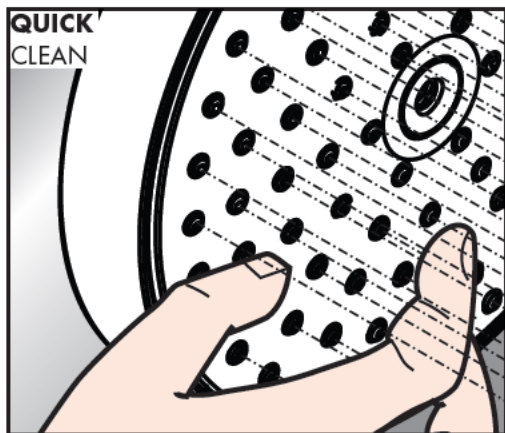



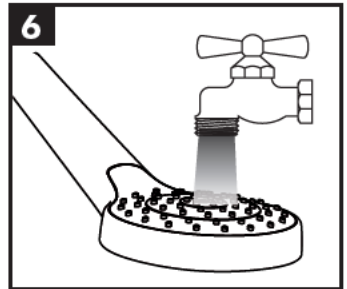
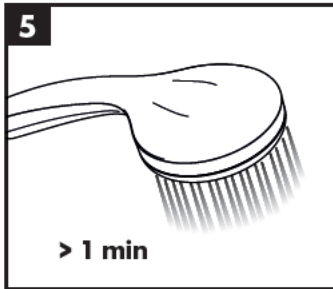
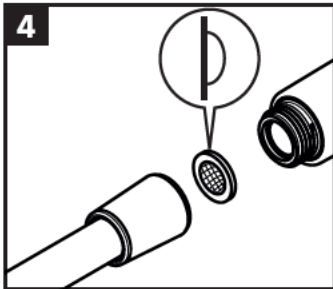
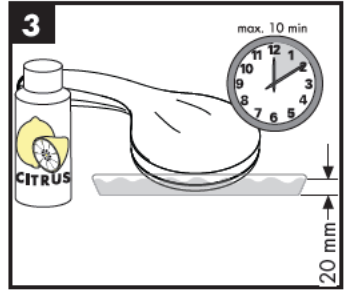
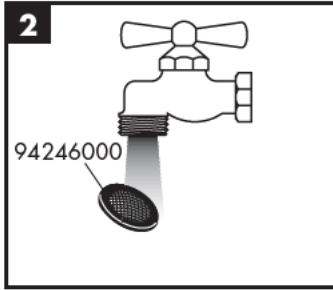
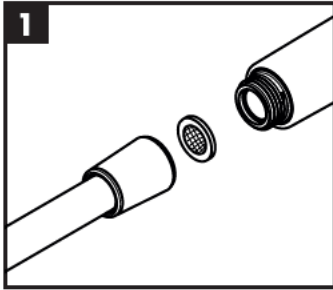

- DE** Einfach sauber: Kalk lässt sich von den Noppen ganz leicht abrubbeln.
- FR** La propreté en toute simplicité: les dépôts formés sur les buses élastiques en silicone s'éliminent par un simple passage de la main.
- EN** Just clean: simply rub over the spray nozzles to remove lime scale.

	P-IX	DVGW	NF
26270XXX	P-IX 28842/IB	BT0633	X



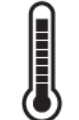

	P max. 0,6 MPa 6 bar	0,1 - 0,4 MPa 1 - 4 bar	
	T max. 60 °C	< 50 °C	

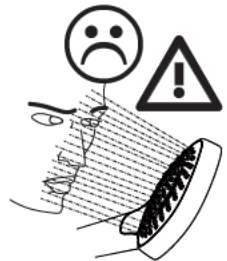
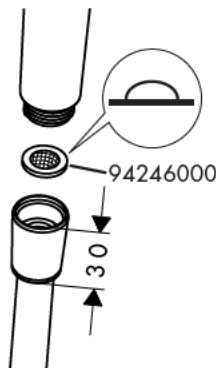
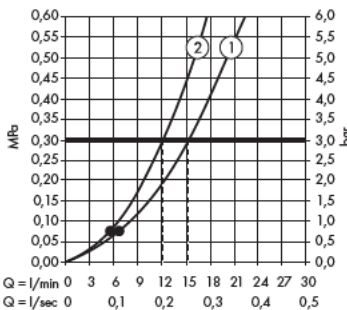

hansgrohe

DE Montageanleitung
FR Instructions de montage
EN assembly instructions

07/2020
9.05046.04

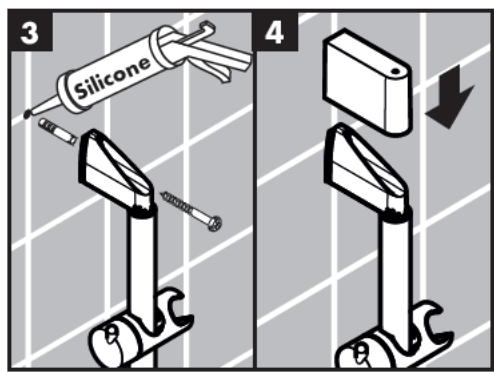
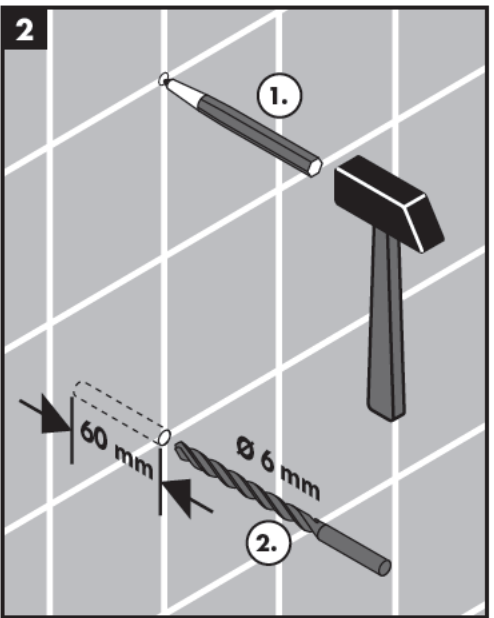
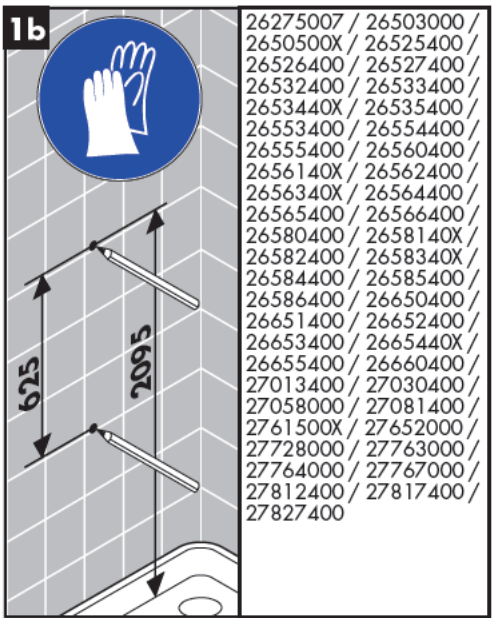
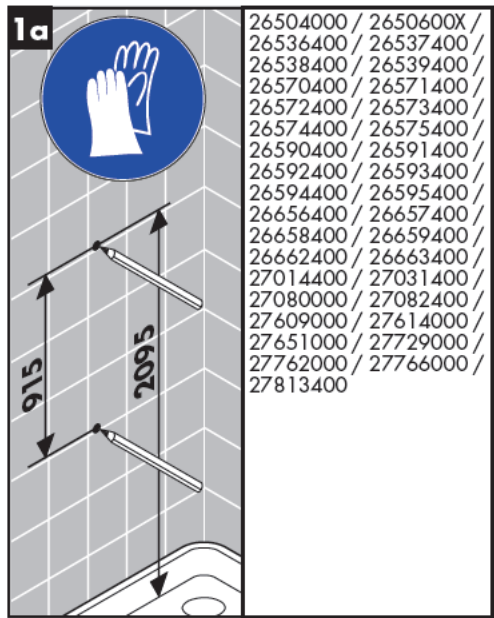
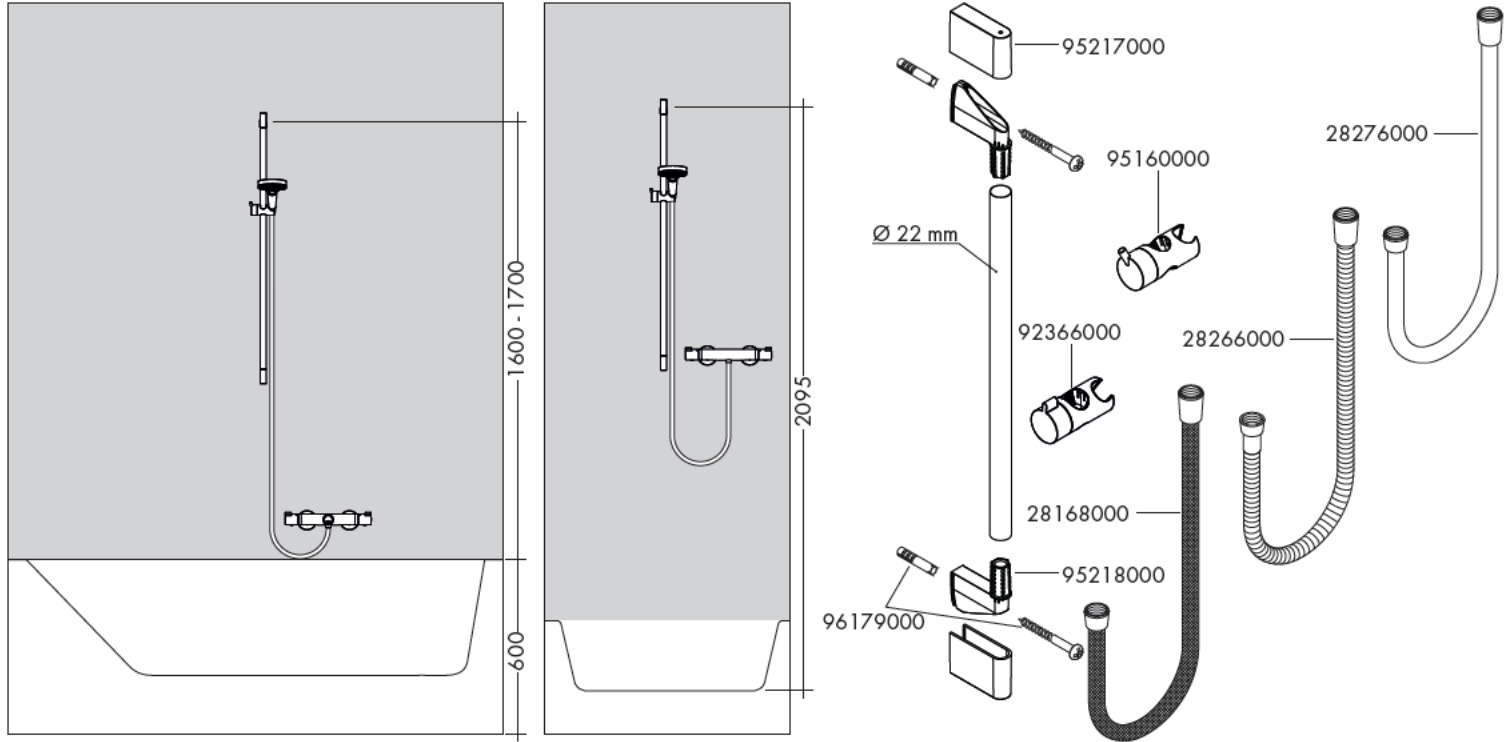

Silikon (essigsäurefrei)
 Silicone (sans acide acétique!)
 Silicone (free from acetic acid!)

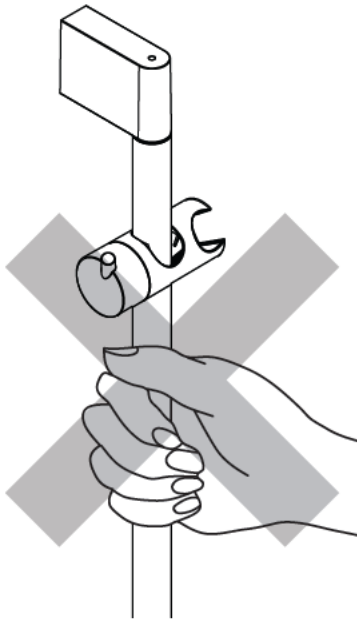

DE Das Produkt darf nicht als Haltegriff benutzt werden.

FR Le produit ne doit pas servir de poignée.

EN The product may not be used as a holding handle.



www.hansgrohe.com/cleaning-recommendation



www.hansgrohe.com/cleaning-recommendation



www.hansgrohe.com/cleaning-recommendation



www.hansgrohe.com/cleaning-recommendation

Classification acoustique et débit: **NF**

26553400

26532400

26561400

26562400

26533400

27728000

27763000

